



# Compact Portable Antenna

CPAK-SB-VHF  
 CPAK-SB-UHF  
 CPAK-1-UHF

## Verify

1. **Part List:** Package includes retractable antenna, RF feed-line with connector, and lanyard (rope). See Figure 1: Parts Diagram.

**Note:** The antenna is also available as a kit which includes cloth case, magnetic mount, and ground stake mount which enables this antenna to stand alone. Please contact STI-CO for details and pricing.

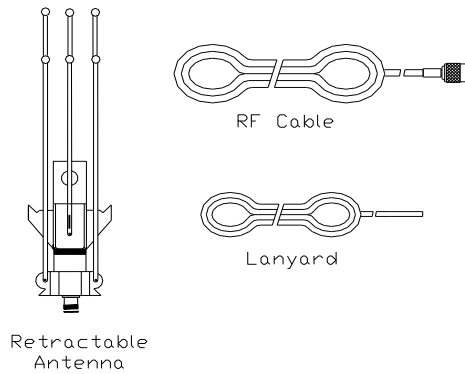
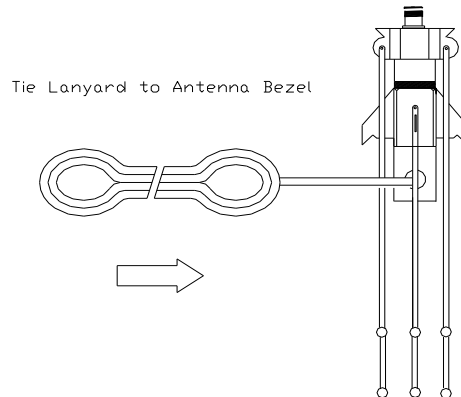

**Figure 1 – Parts Diagram**

2. **Bandwidth:** The UHF antenna is designed to operate with a bandwidth of 106 MHz between 406 MHz to 512 MHz. The low band VHF antenna is designed to operate with a bandwidth of 21 MHz between 135 MHz to 156 MHz. The high band antenna is designed to operate with a bandwidth of 26 MHz between 148 MHz to 174 MHz.

## ANTENNA DEPLOYMENT:

1. Tie lanyard to hole in antenna bezel (See Figure 2: Attaching Lanyard).



**Figure 2: Attaching Lanyard**  
 Page 1 of 4



2. Antenna is ready to throw and or hang from an elevated structure (i.e. branch, telephone wire, hotel patio, etc.)
3. Lower to a level so that the RF cable can be attached to the antenna (See Figure 3: CPAK Antenna Fully Deployed).

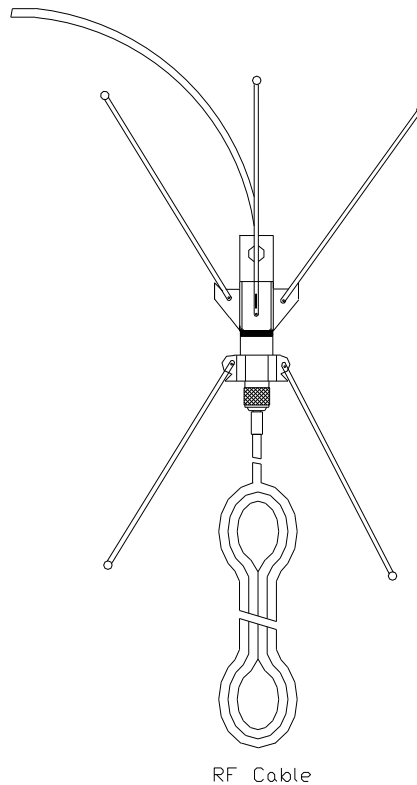

**Figure 3: CPAK Antenna Fully Deployed**

4. Unfold all radials fully to total length
5. Using lanyard, raise or lower to desired height.
6. The compact portable antenna is ready for operation

**Antenna Retrieval**

1. The antenna is engineered so that the ground radials will fold upward if obstructed while being lowered to the ground.
2. Lower antenna assembly and remove the RF cable and lanyard from the antenna.
3. Pull the lanyard from the supporting structure (only after antenna has been removed).

**Note:** The antenna is also available as a kit which includes cloth case, magnetic mount, and ground stake mount which enables this antenna to stand alone. Please contact STI-CO for details and pricing.

See the following pages for a description of these items.



## CPAK MAGNETIC MOUNT ASSEMBLY

The following components are required for proper deployment of the compact antenna using the magnetic mount assembly: retractable antenna, magnetic mount assembly (See Figure 1), and the RF cable with a TNC connector on one end.

### INSTALLATION:

1. Unfold the magnetic mount assembly (refer to Figure 2).

**Note:** There are two options for positioning the magnetic mount in relation to the metallic surface.

2. Place CPAK antenna into the mounting block on top of the magnetic mount. Use the TNC connector at the end of the RF Cable assembly to hold the antenna into place when tightened (see Figure 3).



Figure 1

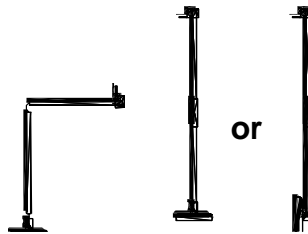

Figure 2

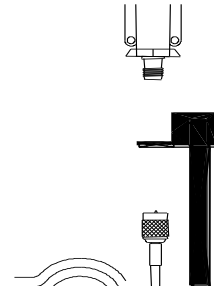
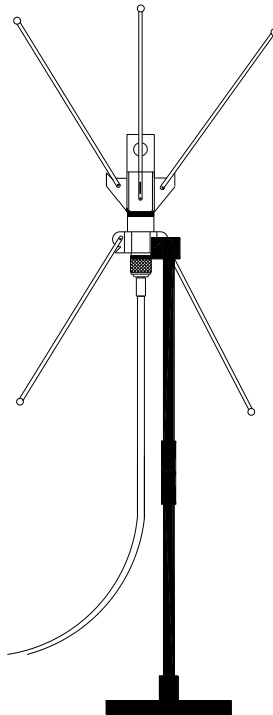

Figure 3

3. Place the magnetic mount assembly on a metallic surface.
4. Once erect; the CPAK antenna can be unfolded as shown below.
5. Run the RF feed-line to your radio and the deployment is complete.





## CPAK STAKE MOUNT

The following components are required for proper deployment of the CPAK using the stake mount; retractable antenna, stake mount assembly (See Figure 1), and the RF cable with a TNC connector on one end.

### INSTALLATION:

1. Unfold the stake mount assembly (refer to Figure 2).
2. Pound the stake assembly into the ground.
3. Place CPAK antenna into the mounting block on top of the stake mount. Use the TNC connector at the end of the RF Cable assembly to hold the antenna into place when tightened (see Figure 3).

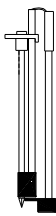

Figure 1

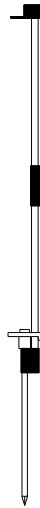

Figure 2

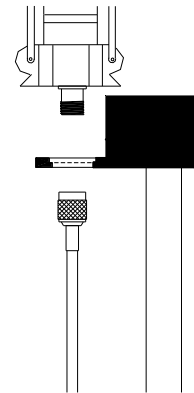

Figure 3

4. Once erect; the CPAK antenna can be unfolded as shown below.
5. Run the RF feed-line to your radio and the deployment is complete.

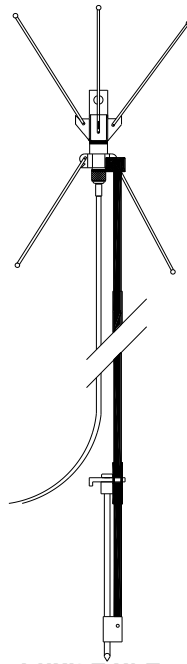

Figure 4

REV 000