

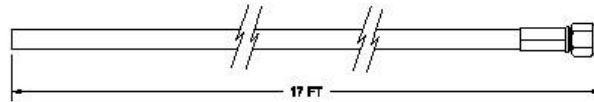

# Installation Procedure for a Glass Mount Antenna Model #: GLMT-DB-XX

## PARTS LIST

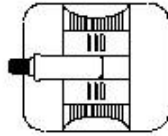

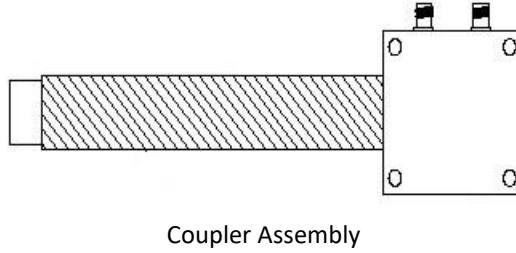
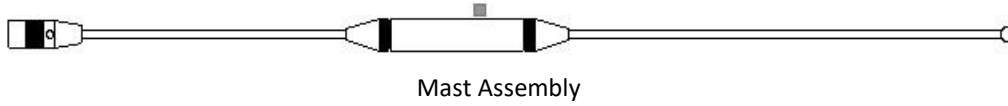

**Note:** Aftermarket tint must be removed before installation. OEM tint will not affect the performance of this antenna.

## Coupler and Antenna Base Installation Steps



**Note:** Be sure to place the antenna base as high on the windshield as possible to insure that the grounding strap on the coupler is long enough to make contact with metal roof



**WHERE POSSIBLE DO NOT INSTALL ANTENNA BASE/COUPLER OVER DEFOGGER LINE OR AM/FM WIRES.** If installation needs to be DIRECTLY OVER a defogger elements or AM/FM wire, install the antenna base between defogger wires, as illustrated on Figure-1

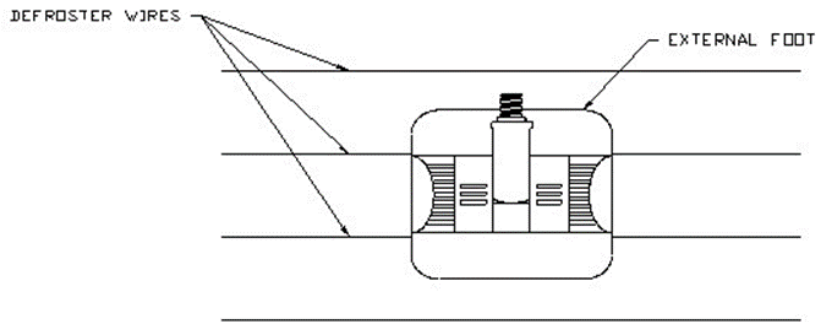

Figure-1

## Coupler Installation



The antenna base and automotive glass must be heated to between 60° and 110° F at the time of installation. A curing time of one hour above 60° F is recommended to achieve maximum bond between adhesive tapes and glass.

1. Trim back the rubber insulation to expose the pre-drilled holes.

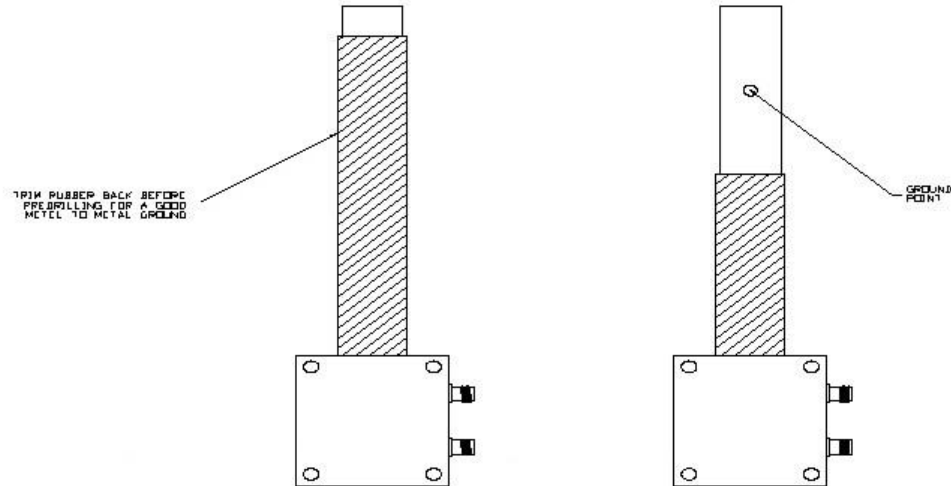

2. Attach grounding straps using #6 x 3/8" sheet metal screw provided
3. Clean the interior glass with the alcohol pad.
4. Remove coupler adhesive backing and adhere to the glass

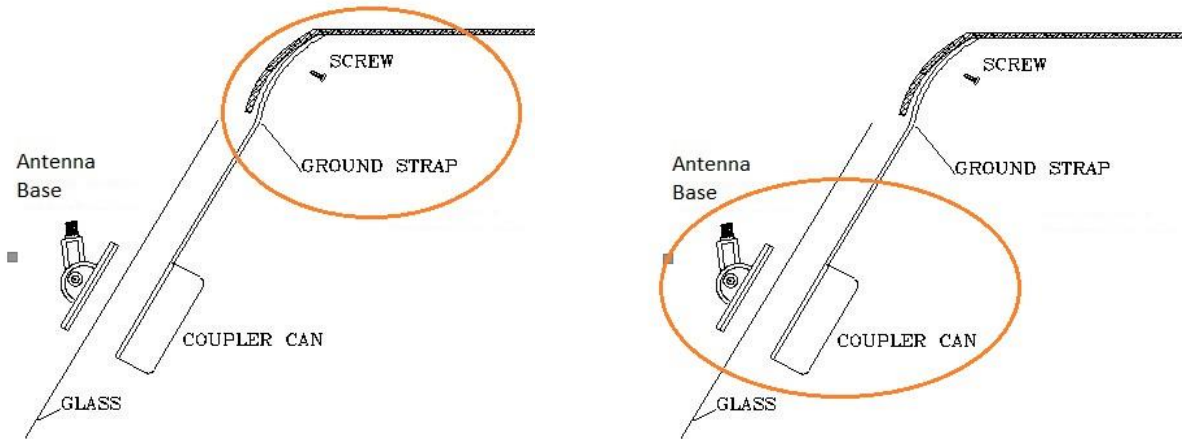

## Antenna Base Installation Steps

1. Clean exterior glass with the alcohol pad in the area of antenna base placement
2. Open packet of GAP-1 (silane glass treatment) and wipe glass to ensure complete coverage
3. Wipe dry with a clean cloth
4. Remove antenna base adhesive and place over the center of the coupler can

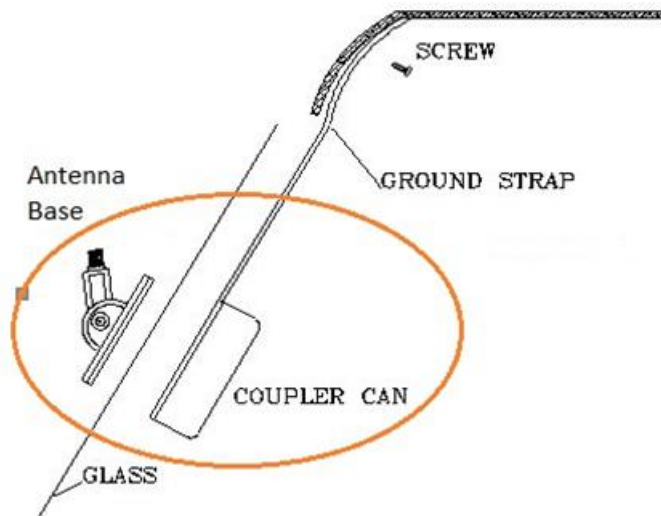
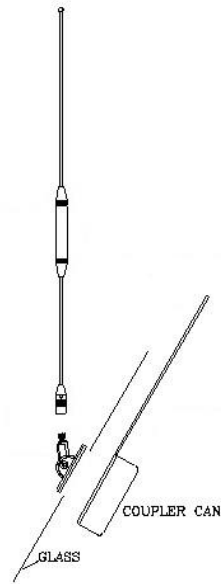

## Antenna Installation

1. Thread the mast onto the foot and tighten the screws so that the mast stands vertically



## Coax Cables Installation



**Note:** do not to tear the outer jacket of coax cable when pulling through sharp body panels. If a hole appears in the cable's jacket, cover with several layers of a high quality electrical tape.

1. Route coaxial cables toward the two-way radio by tucking the cable under the rubber lip of the window trim.
2. If desired, cut the feedline cable to the length required to reach the transmitter.
3. Install connectors

## Electrical Test Verification



Installation testing must take place at the transmitter side of the feedline. Make sure all door, hood, and trunk openings are closed.

**Note:** Some vehicles are sensitive to VHF frequencies. Isolate feedlines and check for unwanted interference with the ignition switch with on, and with vehicle running

1. **Reflected Power:** A measurement of reflected power using a wattmeter, you can expect up to 11% reflected power. When results are greater than 11%, reposition antenna.
2. **SWR:** A measurement of Standing Wave Ratio (VSWR) will yield better than 2:1. If greater than 2:1, reposition antenna.
3. **Continuity:** A test of continuity between the center pin and ground, for this antenna will show as an open.



**CAUTION:** The mast must be removed at threaded section before entering a car wash